

EN The fitting cannot be covered with insulating material.  
 D Nicht zur Abdeckung mit Wärmeisoliermaterial geeignet. Leuchte.  
 F L'article ne peut être recouvert de matériaux isolants.  
 E El aparato no podrá cubrir con material aislante.  
 RUS Осветительный прибор не может быть покрыт теплоизоляционными материалами.  
 I Il podajnik nie może być osłonięty materiałami izolacyjnymi.  
 PL Oprawy nie może być osłonięta materiałami izolacyjnymi.  
 SK Svietidlo nesmie byť kryté izolačnými materiálmi.  
 CZ Světlo nesmí být kryto izolačním materiálem.

EN INSTALLATION INSTRUCTIONS  
 D MONTENGEANWEISUNG  
 F MANUEL D'INSTALLATION  
 E INSTRUCCIÓN DE MONTAJE  
 RUS ИНСТРУКЦИЯ ПО МОНТАЖУ  
 I ISTRUZIONI DI MONTAGGIO  
 PL INSTRUKCJA MONTAŻU  
 SK NÁVOD NA MONTÁŽ  
 CZ NÁVOD K MONTÁŽI

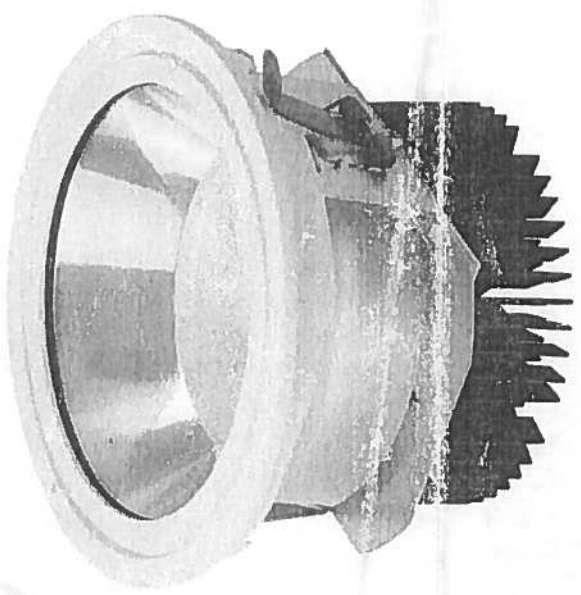

**SLE**

XGS25SE-04

PRETTUS

1.22

**EN** Turn off the power prior to light fixture installation! The light fixture may be installed only by a qualified person. The light fixture must be wired according to respective electrical standards. The manufacturer shall not be liable for any modifications of the product or incorrect installation of the product.

**D** Schalten Sie den Strom vor der Installation der Leuchte aus! Die Leuchte darf nur von einer Person mit Entsprechender Qualifikation angeschlossen werden. Die Leuchte muss gemäss einschlägigen elektrotechnischen Normen angeschlossen werden. Der Hersteller übernimmt keine Haftung, soweit das Produkt geändert oder unsachgemäß installiert wurde. **F** Avant l'installation du luminaire coupez le courant. Le luminaire doit être branché uniquement par une personne qualifiée selon les normes d'installations en vigueur. Le fabricant ne porte aucune responsabilité dans le cas d'une modification du produit ou d'une mauvaise installation. **E** Antes de proceder al montaje, desconecte la corriente eléctrica. La luminaria ha de ser conectada solamente por la persona que posea la calificación adecuada. El fabricante no se responsabiliza de modificaciones del producto o de una mala instalación. **CZ** Před instalací svítidla vypněte proud! Svítidlo musí být zapojeno podle příslušných elektrotechnických norem. Výrobce nese odpovědnost za změny výrobku nebo za chybnou instalaci výrobku.

**RUS** Перед началом монтажа отключите электрическое питание! Подключением светильника может выполнять исключительно специалист. Производитель не несет никакой ответственности за последствия, выданные владельцем средств в конструкции светильника электротехнической маркировкой. Подключение светильника должно производиться соответствующим специалистом. Производитель не несет ответственности за изменения продукта или неправильной установки. **PL** Przed instalacją lampy należy wyłączyć dopływ prądu. Oświetlenie może podłączyć wyłącznie osoba posiadająca odpowiednie kwalifikacje! Oświetlenie może podłączyć zgodnie ze stosownymi normami elektrotechnicznymi. Producent nie ponosi odpowiedzialności w przypadku ingerencji w wyrób lub nieprawidłowej instalacji. **SK** Pred instaláciou svietidla vypnite prúd! Svietidlo musí byť zapojené iba osobou s príslušnou kvalifikáciou! Svietidlo musí byť zapojené podľa príslušných elektrotechnických noriem. Výrobca nese zodpovednosť ak bol výrobok upravovaný, prípadne nesprávne nainštalovaný.

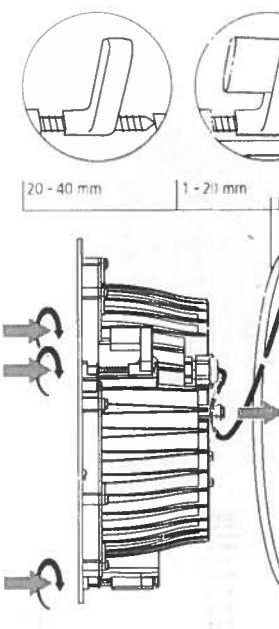
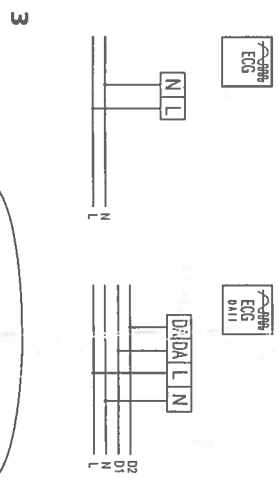
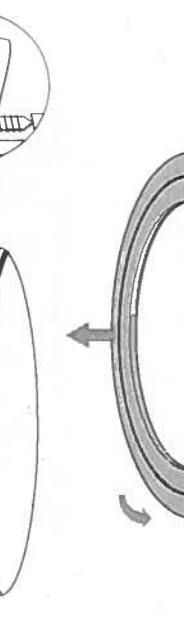
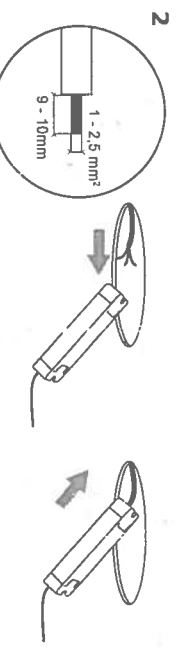
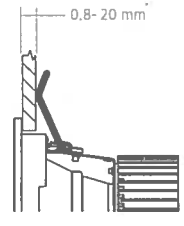
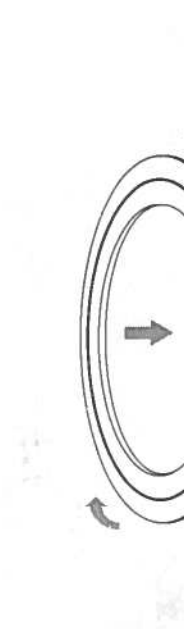
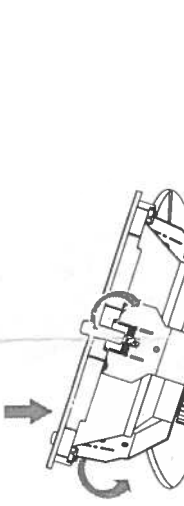
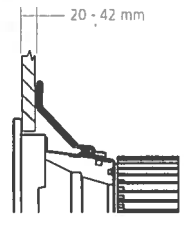
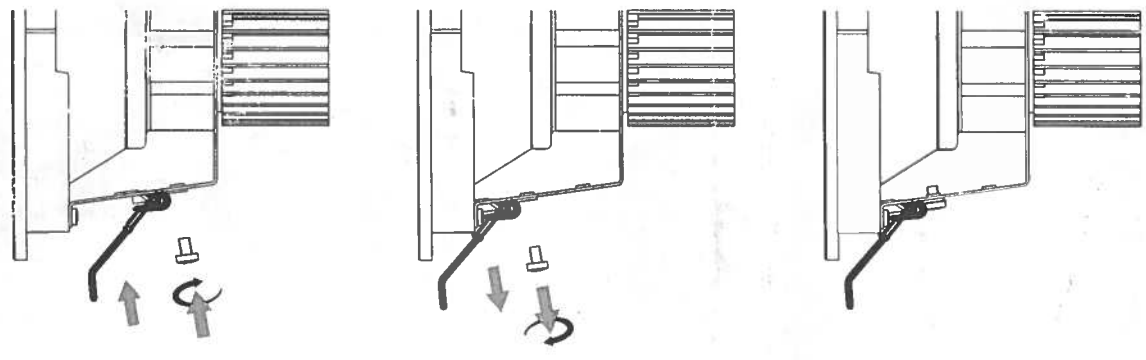

1

2

3

1

2

3

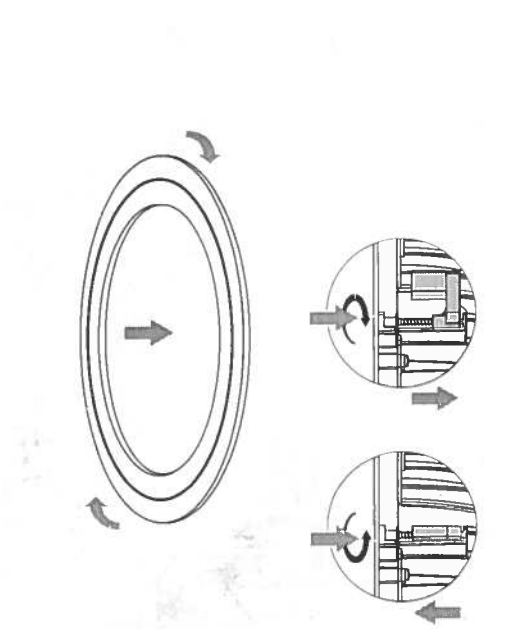
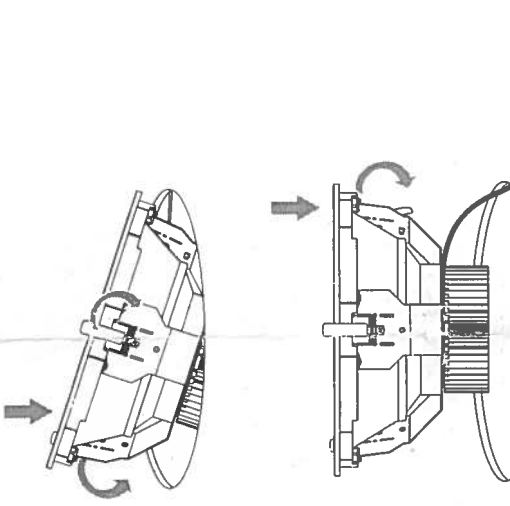

1

2

3

1

2

3

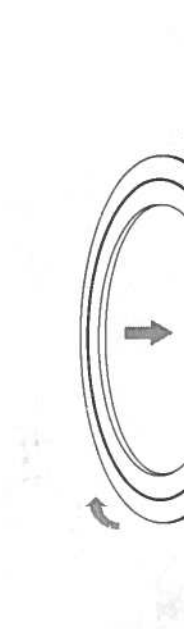
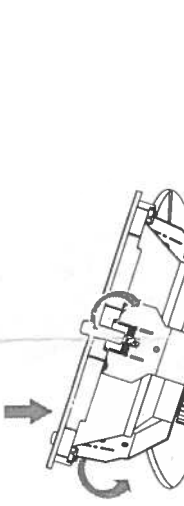

1

2

3

1

2

3

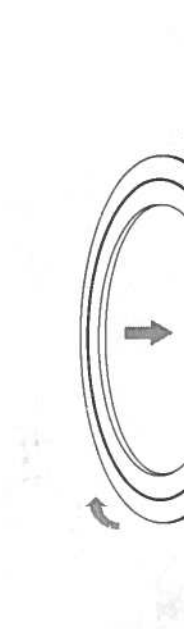
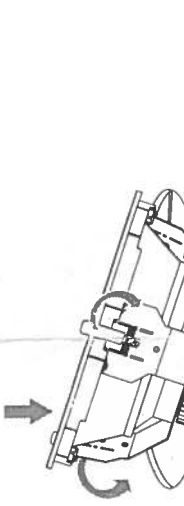

1

2

3

1

2

3

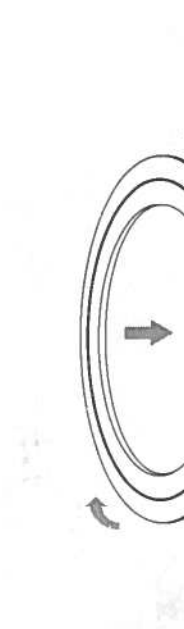
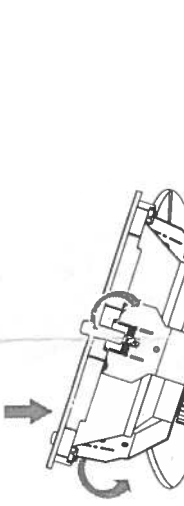

1

2

3

1

2

3

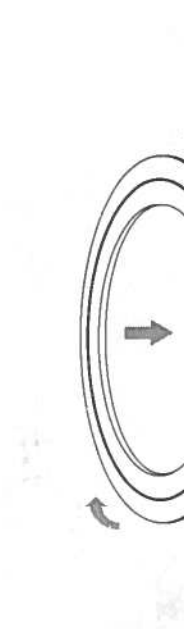
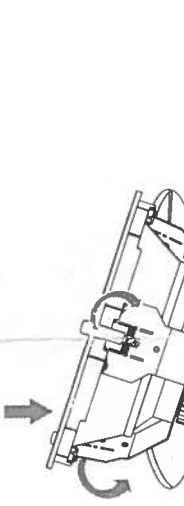

1

2

3

1

2

3

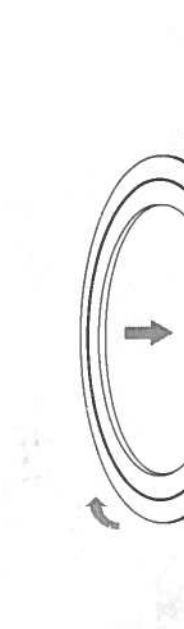
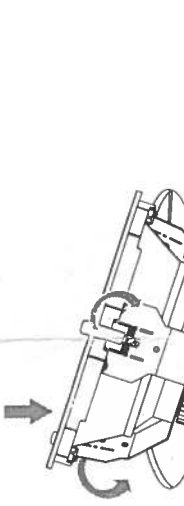

1

2

3

1

2

3

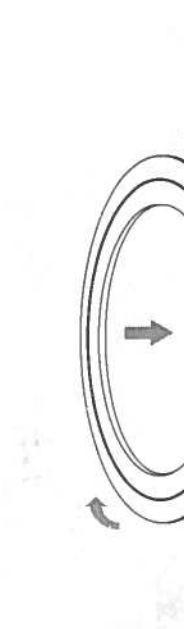
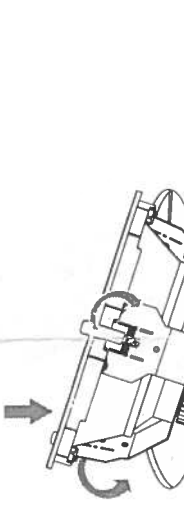

1

2

3

1

2

3

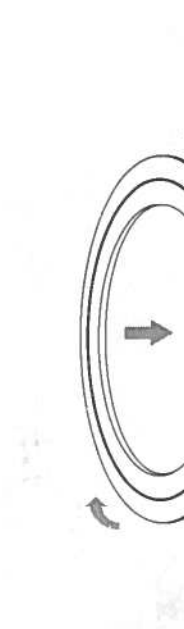
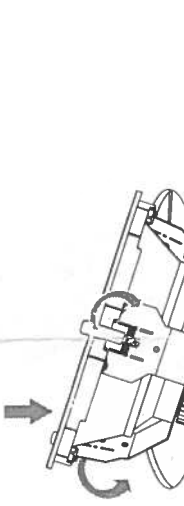

1

2

3

1

2

3

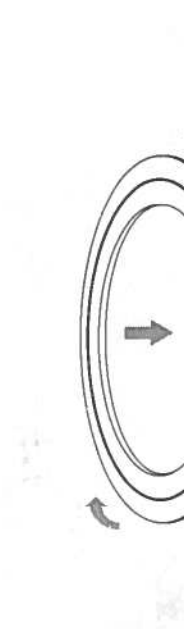
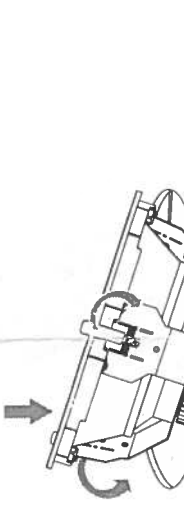

1

2

3

1

2

3

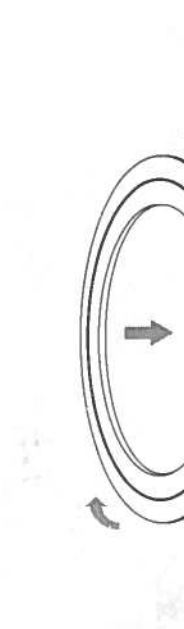
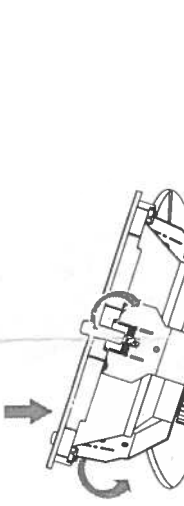

1

2

3

1

2

3

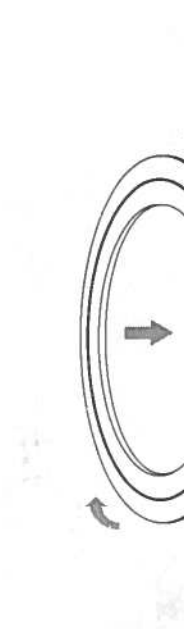
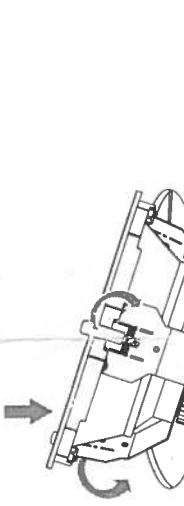

1

2

3

1

2

3

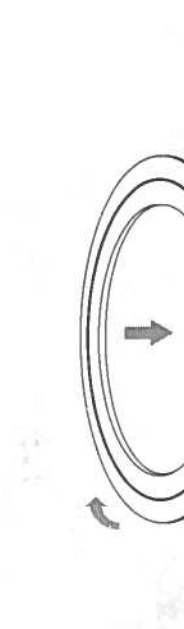
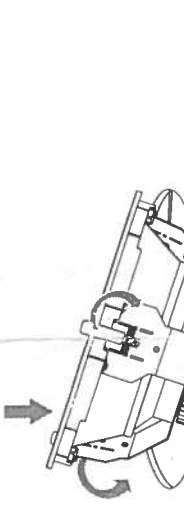

1

2

3

1

2

3

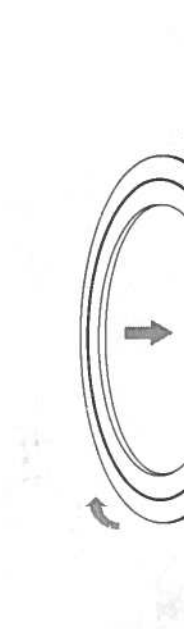
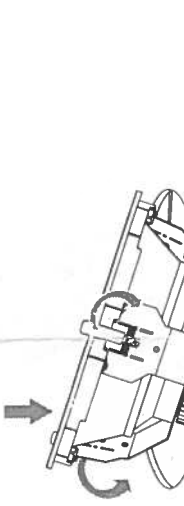

1

2

3

1

2

3

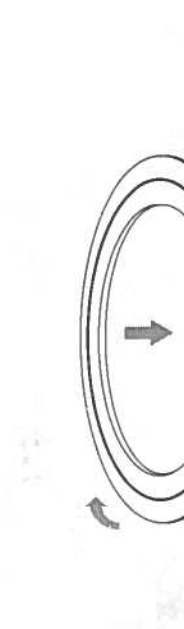
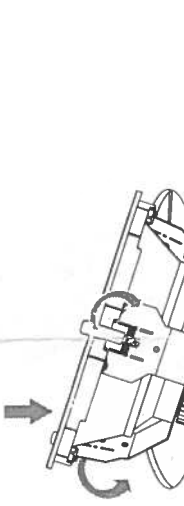

1

2

3

1

2

3

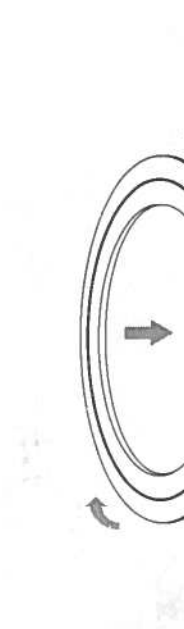
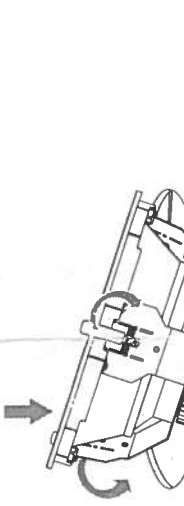

1

2

3

1

2

3

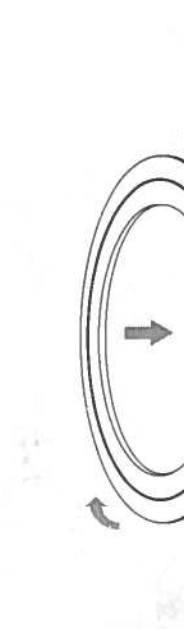
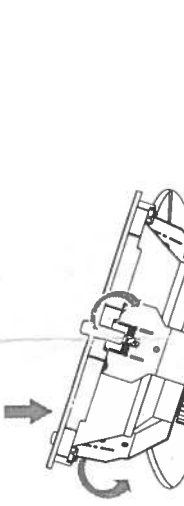

1

2

3

1

2

3

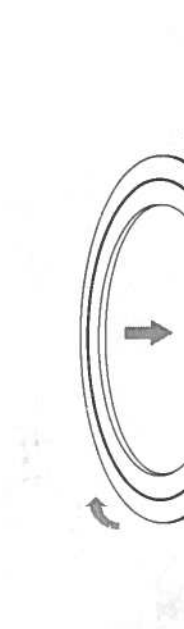
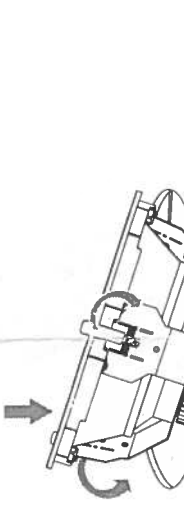

1

2

3

1

2

3

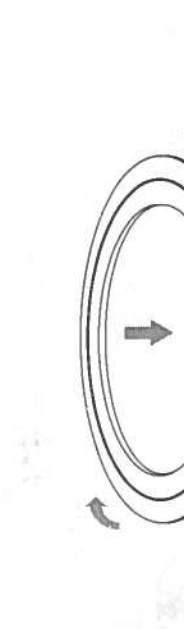
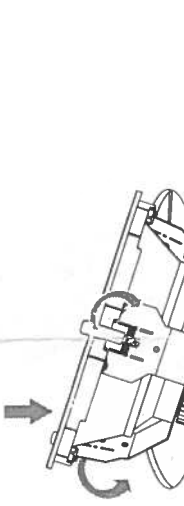

1

2

3

1

2

3

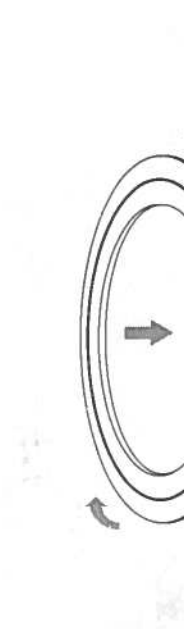
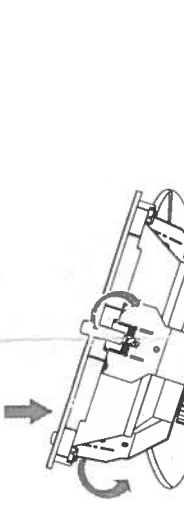

1

2

3

1

2

3

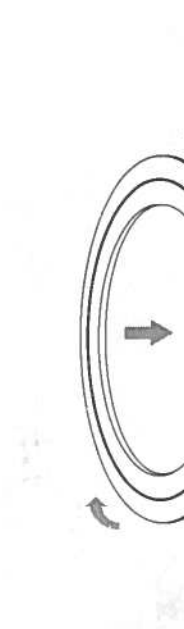
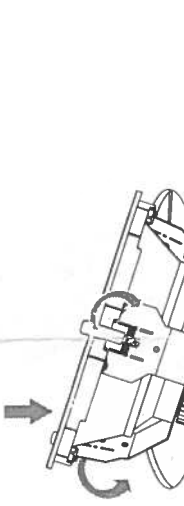

1

2

3

1

2

3

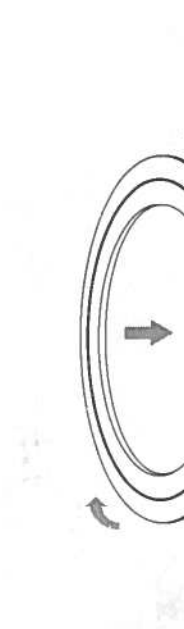
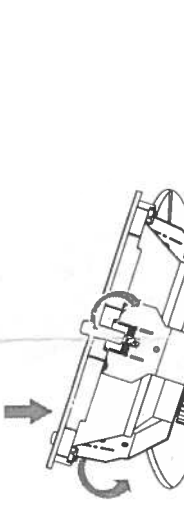

1

2

3

1

2

3

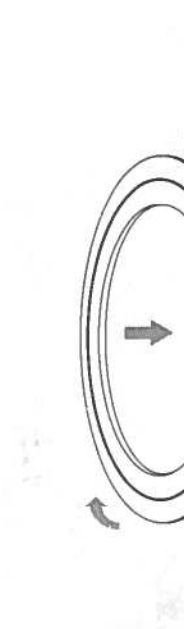
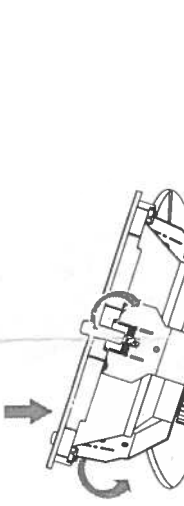

1

2

3

1

2

3

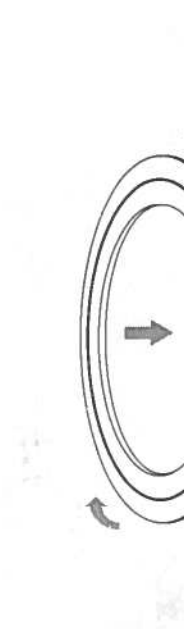
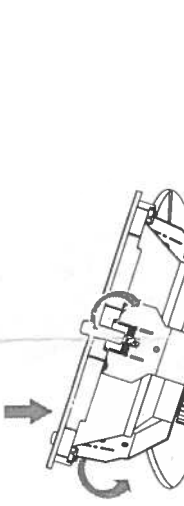

1

2

3

1

2

3

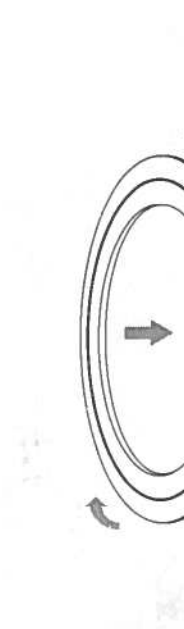
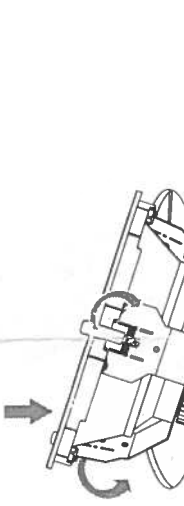

1

2

3

1

2

3

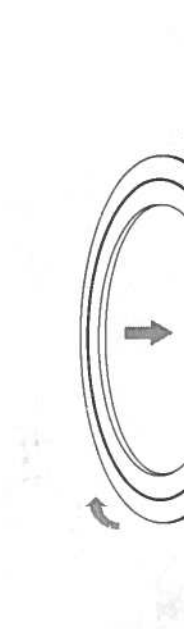
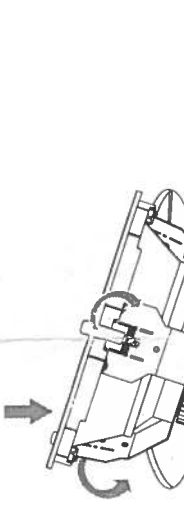

1

2

3

1

2

3

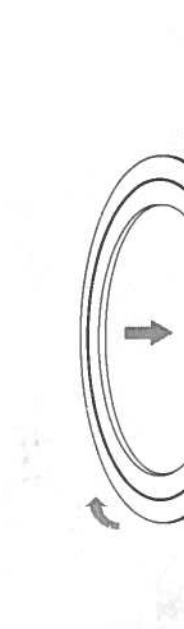
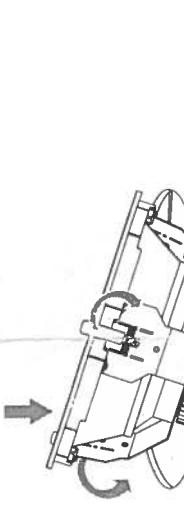

1

2

3

1

2

3

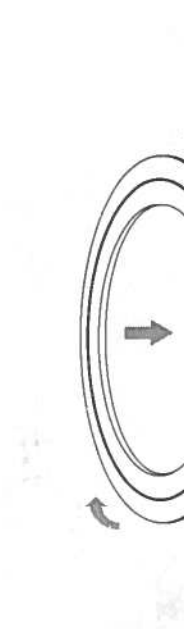
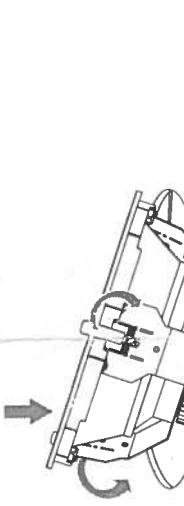

1

2

3

1

2

3

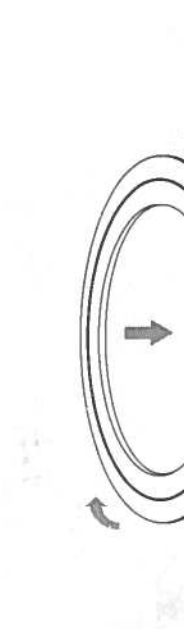
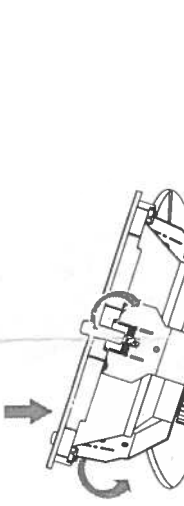

1

2

3

1

2

3

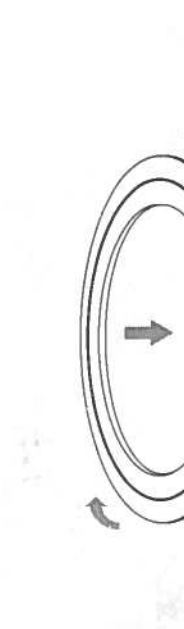
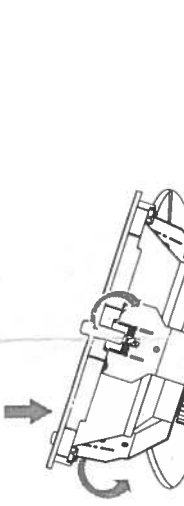

1

2

3

1

2

3

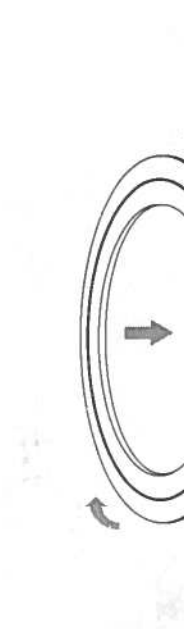
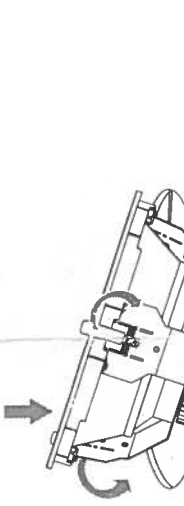

1

2

3

1

2

3

